

(No Model.)

4 Sheets—Sheet 1.

D. E. FELT.
ADDING MACHINE.

No. 371,496.

Patented Oct. 11, 1887.

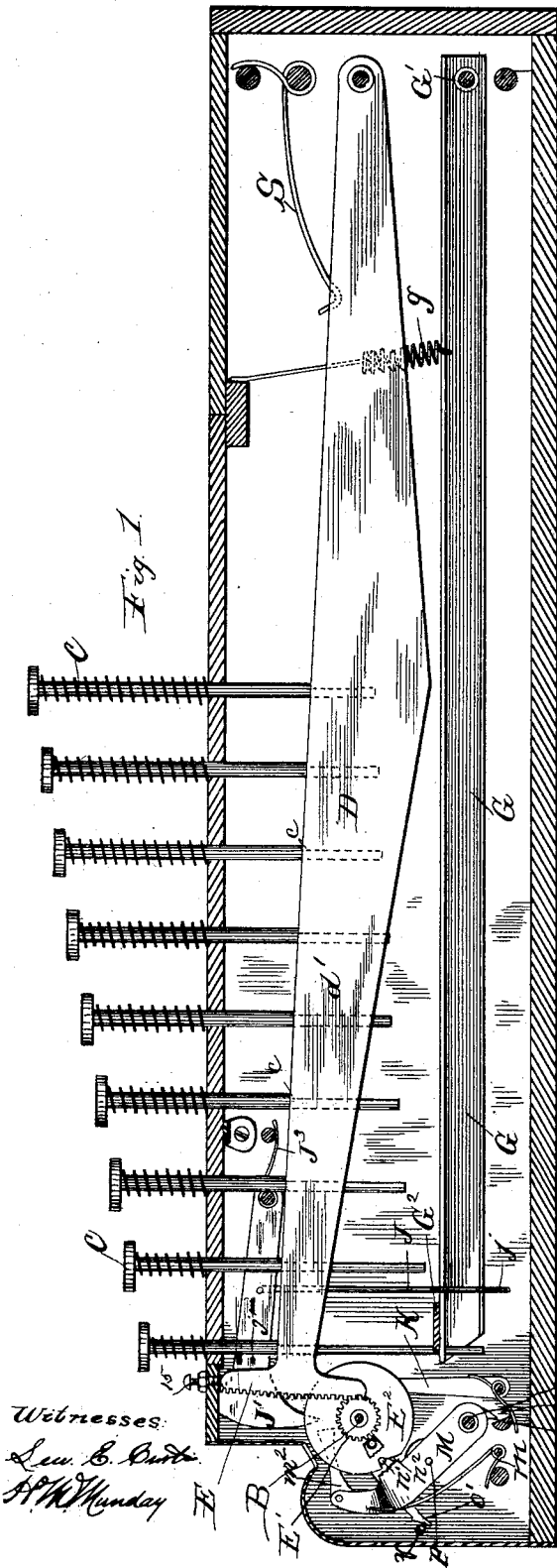

Fig. 1.

Witnesses:
Lew. E. Curtis
A. W. Munday

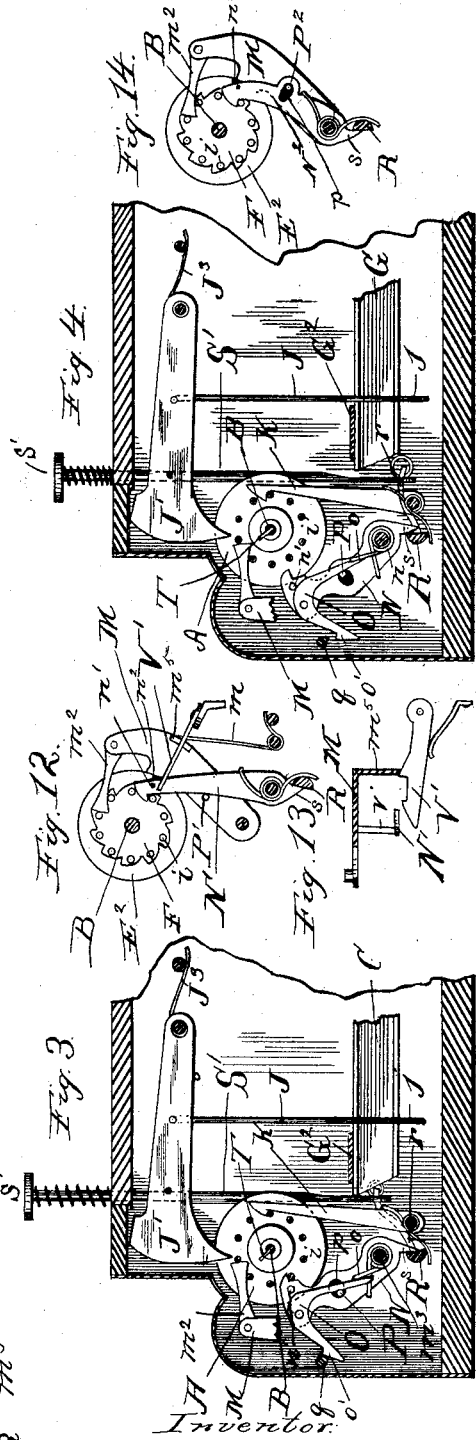

Fig. 3.

Fig. 4.

Fig. 12.

Fig. 13.

Fig. 14.

Inventor:
Dorr E. Felt.

By Munday Curtis & Coak
Attorneys.

D. E. FELT.
ADDING MACHINE.

No. 371,496.

Patented Oct. 11, 1887.

Fig. 2.

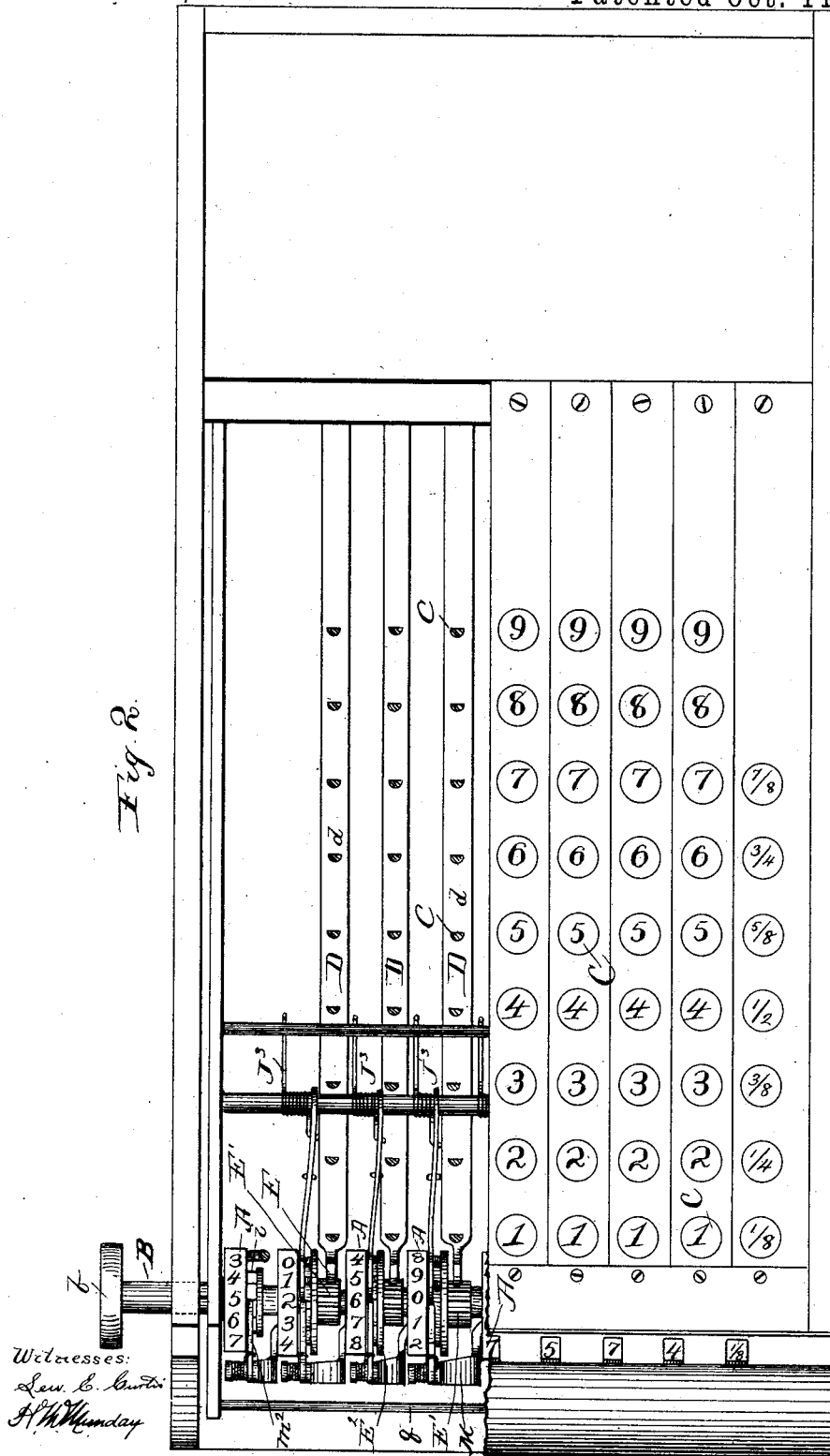

Witnesses:
Law. C. Curtis
A. W. Monday

Inventor:
Dorr E. Felt
By
Monday
Evarts &
Adcock
his Attys:

D. E. FELT.
ADDING MACHINE.

No. 371,496.

Patented Oct. 11, 1887.

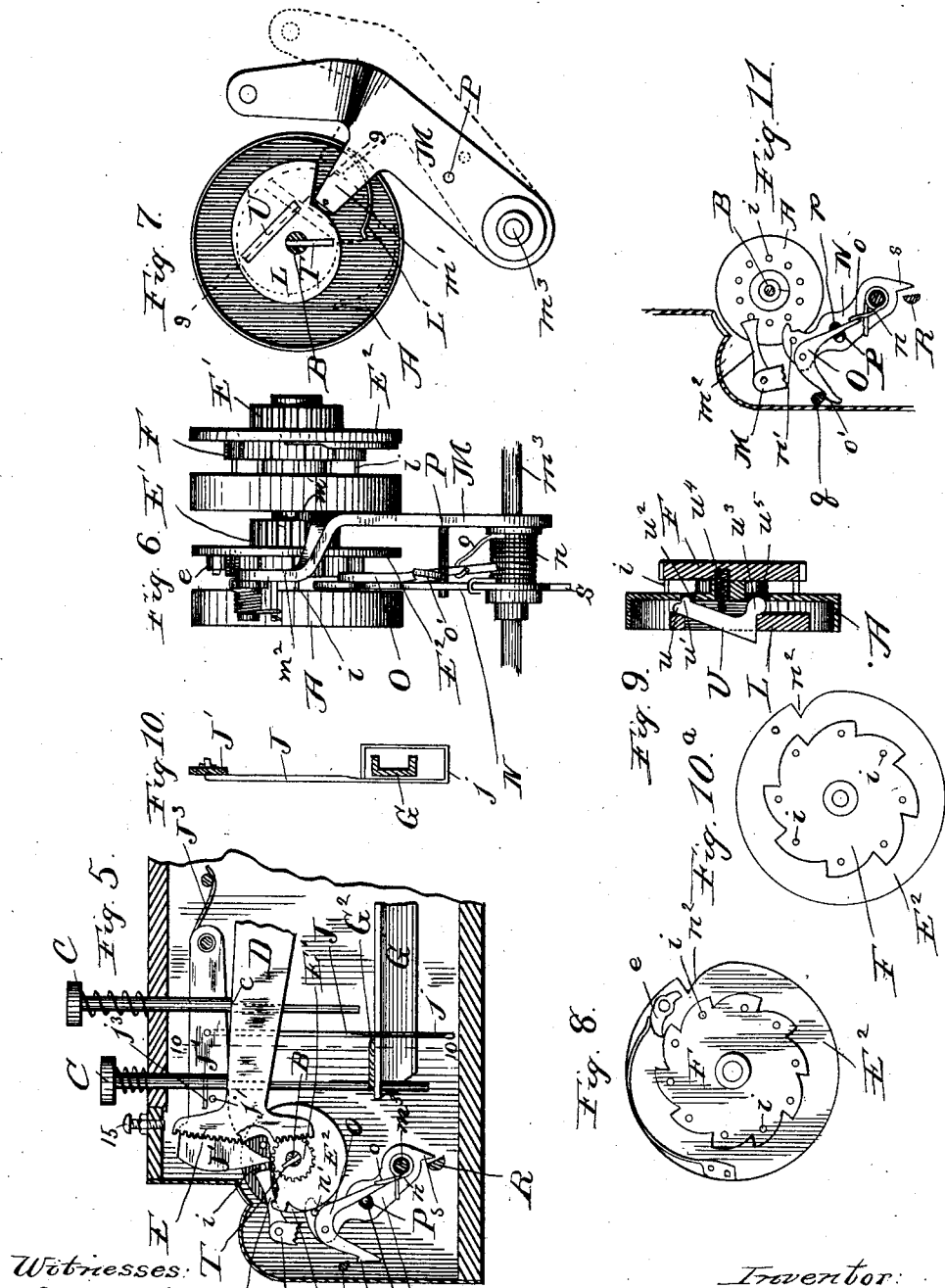

Witnesses:
 Lew. C. Burke
 A. M. Munday

Inventor:
 Dorr F. Felt.

By Munday Evans & Co.

His Attorneys.

D. E. FELT.
ADDING MACHINE.

No. 371,496.

Patented Oct. 11, 1887.

Fig. 15.

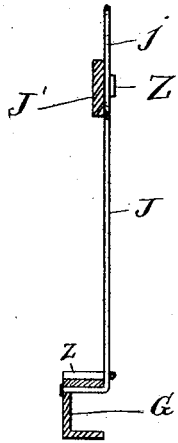

Fig. 16.

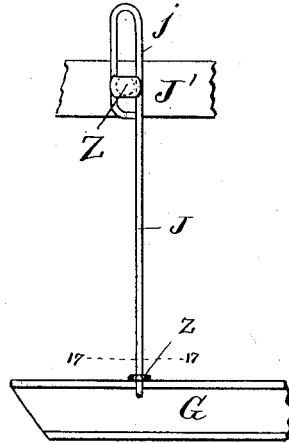

Fig. 19.

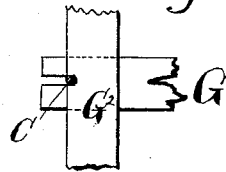

Fig. 17.

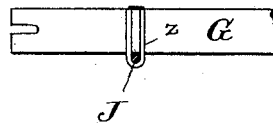

Fig. 18.

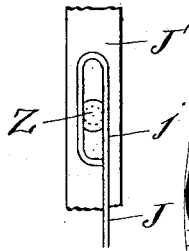
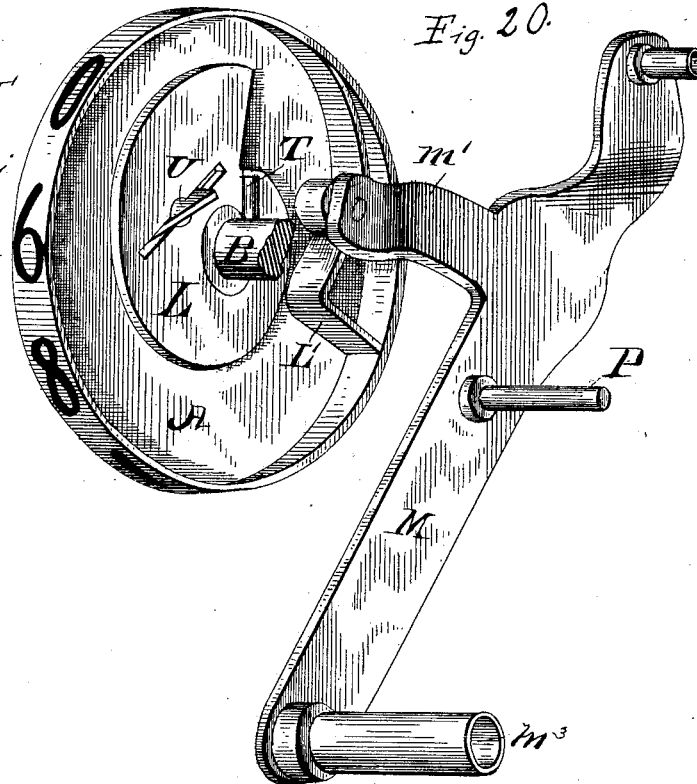

Fig. 20.



Witnesses:
Leu. C. Curtis
S. W. Munday

Inventor:
Dorr E. Felt.

By Munday, Curtis & Adcock
his Attorneys.

UNITED STATES PATENT OFFICE.

DORR E. FELT, OF CHICAGO, ILLINOIS, ASSIGNOR TO HIMSELF AND CHAUNCEY W. FOSTER, OF SAME PLACE.

ADDING-MACHINE.

SPECIFICATION forming part of Letters Patent No. 371,496, dated October 11, 1887.

Application filed March 12, 1887. Serial No. 230,653. (No model.)

To all whom it may concern:

Be it known that I, DORR E. FELT, a citizen of the United States, residing in Chicago, in the county of Cook and State of Illinois, have invented a new and useful Improvement in Adding-Machines, of which the following is a specification.

This invention is an improvement upon the machine set forth in my patent filed July 6, 1886, and numbered as Serial No. 366,945, dated July 19, 1887.

To properly define the position of this invention in the art, I desire to say that machines of this order may be conveniently divided into two classes—viz., counting-machines and calculating-machines. I call counting-machines those wherein a series of numeral wheels are actuated by impulses or strokes delivered to the first or units wheel and periodically transmitted to the succeeding wheels of the series by carrying mechanism, so that at the completion of the tenth step of one wheel the wheel of the next higher order will be caused to advance one step. Each wheel being numbered from 1 to 10, the quantities indicated proceed in decimal order. Machines of this class are common and are well understood. It is evidently desirable that overrotation shall be prevented, and therefore the numeral-wheels have been provided with stop-motion devices, sometimes simple friction devices, sometimes a positive stop, acting momentarily—that is to say, automatically released again immediately—and sometimes a positive stop remaining in action until just before the completion of the revolution of the wheel next lower in order, so that the release takes place just in time for the next succeeding impulse. Calculating-machines are those wherein there is a series of numeral-wheels the same as in counting-machines and provided with similar carrying mechanism; but in addition each wheel has mechanism whereby it may be actuated and at a single motion caused to revolve independently through any part of its revolution.

Stop-motion devices to prevent overrotation are not more necessary in a calculating-machine than in a counting-machine; but the stop-motion devices suitable for the latter are insufficient and inapplicable to the former for

these reasons: First, it is necessary that each wheel shall be arrested and automatically locked during its period of rest, because the correctness of the calculation depends upon the presence of each wheel in its true position at the time when it receives its forward impulse, and, second, it must be adapted to be unlocked by the carrying device, and also by its own key-actuating device. The simple friction stop is inapplicable because it is not positive and is not reliable. The momentary stop, which is released immediately after action, is inapplicable, because when the machine is being driven very rapidly it will frequently happen that the stop-motion device advances and is withdrawn again so quickly that it fails to arrest the numeral-wheel, which then continues its movement and finally rests out of position. This, of course, falsifies the result. The stop-motion device, which remains in action until the wheel of the next lower order is near to the completion of its revolution, is inapplicable, because it will prevent any movement of the numeral-wheel by its own key. Therefore the automatic stop-motion device must be independently released by its own key mechanism, as well as by the carrying part, which is actuated by the numeral-wheel next lower in order. So far as I am aware, no calculating-machine has been provided with means for locking its numeral-wheels during their periods of rest and for unlocking said locking means independently by the carrying device and by the wheel's own key-actuating device.

The main feature of my present invention is the provision of a positive stop-motion device applied to the numeral-wheels and called into operation whenever a number is carried from one column to another, and said stop-motion device remains in engagement with the wheel acted upon until the wheel next lower in order has nearly completed its revolution, or until released by the key-actuating mechanism pertaining to the wheel arrested by said stop-motion device, thereby preventing such wheels from overrotation under the power thus received. This stop device and the stop device to prevent overrotation of the wheels when receiving power directly from the keys together effectually do away with the evil of over-

movement by the wheels, while neither of them alone can prevent it entirely. As the carrying mechanism works quickly, the liability upon the part of the wheel actuated thereby to move beyond the proper point is very considerable.

Another feature of importance is the imparting of motion to the key-stop levers an instant before they actuate the stop-motion devices, or, in other words, the getting of said levers under way before they begin their work. In this manner they are caused to act quickly when they do act, so that the stop-detents move decisively and arrest the wheels instantly and positively.

There are other branches of the invention, some of which relate to the mechanism for setting the wheels preparatory to commencing an adding operation, all of which will be fully understood by reference to the accompanying drawings and the subjoined description, in the former of which—

Figure 1 is a longitudinal vertical section of my improved machine. Fig. 2 is a partial plan and partial horizontal section of the same. Figs. 3 and 4 are partial sections, showing the stop-motion devices employed with the carrying mechanism in two different positions. Fig. 5 is a partial section similar to Fig. 1, some of the parts being broken away. Fig. 6 is a front elevation of two adjacent numeral-wheels, showing the carrying part and its stop mechanism used with one of them. Fig. 7 is a side elevation of one of said wheels, showing the cam and the spring-lever used in carrying. Fig. 8 is a detail side view of one of the disks and ratchets accompanying each numeral-wheel and the pawl for giving motion to the ratchet. Fig. 9 is a section on line 9 9 of Fig. 7. Fig. 10 is a section on line 10 10 of Fig. 5. Fig. 10^a is a view of the ratchet shown in Fig. 8, the number of teeth being changed to adapt it to use with fractions. Fig. 11 shows the carrying stop-motion with some of the parts in a slightly different position from those shown in the other figures. Figs. 12 to 18, inclusive, are modifications of portions of the machine, Fig. 17 being a section on line 17 17 of Fig. 16. Fig. 19 is a detail horizontal section showing the junction of the lowest key of one of the series with the cross-bar G² and stop-lever G. Fig. 20 is a perspective view of the parts shown in Fig. 7.

In said drawings, in which similar letters of reference indicate like parts, A A represent the numeral-wheels, whereof each stands for an order of numbers or fractions of numbers, and all are mounted upon the single shaft B.

C C represent the operating-keys, there being a series for each order of numbers or fractions and each key having the power noted upon it.

D D are the vibrating spring-levers operated by the keys, there being one such for each series of keys. These levers are made of angle shaped metal, the horizontal portion *d* being perforated for the passage of the keys, and the vertical web *d'* serving to stiffen the

lever and render it rigid. The keys are provided with shoulders *e*, engaging with the levers D, whereby when they are struck they depress the latter against the power of the springs S, the free ends of which are hooked under the horizontal web of the levers D, as indicated by dotted lines in Fig. 1. The levers carry toothed segments E, which mesh with and rotate pinions E' upon the shaft B. Adjoining the pinions E', and either integral with or fast thereto, are disks E², carrying spring-depressed pawls *e*. These pawls, when the pinions and disks are rotated by the downward movement of the levers, engage with and carry forward ratchets F, but do not return the latter during the contrary rotation caused by the return-stroke of the levers. The ratchets F are firmly joined to the numeral-wheels and rotate with them, and the extent of the rotation varies with the power of the key struck, the throw of the segment-levers being in accordance with such power. To obtain this variation the keys are graduated in length, as described in my patent, No. 366,945, and the levers are likewise stopped at the proper point by suitable mechanism.

G G are the key-stop levers, there being one for each series of keys, placed directly under the segment lever of the different series. They are struck and operated by those portions of the keys which project through the segment-levers, as shown. Instead, however, of mounting these stop-levers upon laterally-located pivots at each end, I pivot them upon the cross shaft G' at the rear of the machine, and graduate the length of the keys so that all will impart about the same amount of movement to them. For strength and rigidity, the stop-levers are made of U shaped or channel metal, as shown at Figs. 5, 10, 15, and 16.

The stop-levers are connected to the vibrating detents J' by the rods J, which are joined to the detents at their upper ends, and are formed into loops *j*, inclosing the stop-levers at their lower ends. (See Fig. 10.) When the stop-levers strike the bottom of these loops *j*, they carry the rods and detents with them and cause the detents to engage the equispaced teeth or wires *i*, secured in the numeral-wheels and their companion ratchets F, thereby absolutely stopping the rotation of the latter parts. The detents are lifted out of engagement with the wheels by the springs J², and the stop-levers are raised by the springs *g*. The cross-bar G² forms a stop to the upward movement of the stop-levers.

My present mode of actuating the stop-motion detent J' differs, however, in some respects from my former application. Thus the lowest or first key of each series is connected to and actuates the detent directly. The detents for this purpose are provided with laterally-extending pins *j'*, which are engaged by the forwardly-extending-arms *j''* upon the keys, (see Fig. 5,) whereby, when the keys are depressed, the detents are called into action. These same keys may, however, be called upon to serve a

useful purpose in guiding the stop-levers, the forked ends of the latter (seen at Fig. 19) receiving the prolonged lower ends of said keys and sliding up and down the same.

5 Another feature in which I vary from my former construction is this: The loops j are elongated vertically, so that the stop-levers G must move some distance before they begin to actuate the detents. I find this is important, 10 because if the detents begin to move simultaneously with the levers the resultant action of the detents is not quick enough when the keys are struck rapidly, and the overrotation of the numeral-wheels is not effectually prevented; but by getting the levers under way 15 before they act the detents are caused to move with the celerity needed to prevent the evil referred to.

20 The extent of the stroke imparted to the segment-levers by the various keys is regulated by the engagement of the detents with the numeral-wheels, each key being calculated to bring the detent into action when the numeral-wheel has been rotated to the proper 25 point. The set-screws 15 are also useful in adjusting the stroke of the segment-levers and determining their upper position. The lowest keys of the several series pass through notches in the cross bar G^2 , Fig. 19; so they are held 30 against lateral deflection at both top and bottom. This enables them to steady the segment-levers at their moving ends, and the stop-levers also.

35 Spring-actuated stops K engage with the teeth i and prevent backward rotation of the numeral-wheel.

40 In my present machine I store up power whereby to actuate the carrying mechanism, as in my previous machine. The indicator-wheels are provided with cams L , (see Fig. 7,) and a pivoted carrying-lever, M , is located adjacent to each wheel, and forced toward the wheels by the spring m . (See Fig. 1.) Each 45 lever M has an arm, m^1 , riding upon cam L , and also a push-pawl, m^2 , engaging with the teeth i of the wheel next higher in order, the lever M being bent laterally, as shown in Fig. 6, to bring the pawl m^2 in line with the ratchet of the wheel next higher in order. The pushing 50 back of the lever M to the position indicated in dotted lines at Fig. 7 by the cam L stores up power in the spring m , which, when the arm of the lever has passed the highest part of the cam, is utilized in returning the lever 55 to its starting position and in carrying the next higher wheel one point or number. Each of the wheels, except the lowest, may be thus actuated, and several of them may be simultaneously actuated by this carrying mechanism. 60 It is not necessary that the cams should exert any pushing force against the levers until the wheels have been rotated to indicate 4, or thereabout, and hence the cams are circular for a portion of their outline.

65 It will be evident that in a machine having a series of keys for each numeral-wheel the speed with which each wheel is moved will be

much greater when a high numeral-key is struck than when a low one is struck. In Fig. 7 the numeral-wheel with its cam and the arm 70 M are shown in their initial position. When the wheel is rotated slowly, the spring m will promptly return the lever M as its arm passes off the point of the cam; but when the wheel is rotated very rapidly the momentum of the 75 outward movement of the lever M is so great that the spring m is occupied for a moment of time in overcoming and reversing this motion, and during that moment the numeral-wheel will pass so far forward that the carrying part 80 will fail to act. To prevent this overmotion, the cam L' is inserted to return the arm M positively when the motion is too rapid for the spring m . (See Fig. 20.)

85 The stop-motion mechanism for preventing overrotation of the carried wheels when actuated by their carrying devices will next be described. There is, of course, a mechanism of this sort for each of the numeral-wheels. Upon the shaft m^3 , whereon the carrying-levers may 90 also be journaled, are pivoted a series of detents, N , one for each numeral-wheel, and springs n press such detents toward the wheels at all times. These detents are intended to engage with the teeth i , and are always in locking 95 engagement therewith when at rest, except when the numeral-wheel next lower stands at 7, 8, or 9, or when released momentarily by the keys. It will thus be seen that this part of the stop-motion mechanism serves a very 100 useful and additional function, and that by means of the detents N on the one side and the stops K on the other all the wheels are absolutely locked during the major part of the 105 time. To release the wheels from this lock by the detents N , pins n' at the upper ends thereof are provided to ride upon the peripheries of the disks F^2 , and as such disks are notched, as at n^2 , the pins resting in the notches during 110 the locking, it follows that the pins and the detents are forced outward whenever the disks are rotated by the segment-levers. The detent N and its spring and pin are employed with the lowest numeral-wheel; but the rest of the stop motion mechanism is not necessary 115 with that wheel, as it is never actuated by carrying mechanism.

Upon the detents N are pivoted bell-crank levers O , the downwardly-extending limb of which is acted upon by a spring, o , and the 120 other limb whereof is provided with catch o' at its extremity. The spring o presses said lower limb toward the front, and thus tends to lift the other limb.

125 The carrying-levers M are each provided with a laterally-projecting pin or stud, P , which extends through the wide opening p in the detents N , as indicated, in position to act upon the detent itself and upon the lower limb of the bell-crank lever O . The catch o' engages at each carrying operation with a transverse bar, q , extending from side to side of the machine, and the other limb of the lever O extends past said pin P , upon the inside thereof. 130

The bell-crank O and bar *g* serve to detain the stop-detent N a sufficient time to permit the carrying-lever to move the numeral-wheel and prevent said detent from engaging too soon.

5 The stud P strikes the downward-projecting arm of the bell-crank O and releases the catch from said bar *g* in time to permit the detent to engage one of the pins *i*.

10 The parts just described constitute, in combination with the detents N, the stop-motion of the carrying mechanism, and its operation is as follows: If the keys of any column—as, for instance, the units-column—be struck, the carrying-lever M, actuated by the cam of the
15 units-wheel, will commence to move backward from the wheel from the time said wheel indicates 4 until it has reached 9. In the backward movement of the carrying-lever, the stud P comes in contact with the edge of
20 the opening *p* in the detent N of the wheel next higher in order at the moment when the wheel which actuates said carrying-lever indicates 7, so that said next higher numeral-wheel is, when the time arrives for it
25 to be moved, released from the locking-action of its own detent N. During the latter part of the backward movement of the detent the upper limb of the bell-crank lever comes in contact with the bar *g* and is deflected
30 thereby until, by the continued movement of the detent, the catch of said upper limb becomes caught by the sharp edge of said bar. This takes place when the keys have brought
35 the units-wheel to 9. The parts are now in the position illustrated at Fig. 11, with the pin P at the same side of the opening *p* occupied during the backward movement, but the lower limb of the lever O stands toward the farther side of said opening. The continued
40 rotation of the units-wheel from this point, whether due to a key-stroke already given or to a stroke to be given or to the action of the carrying part, will result in carrying the highest part of the cam L of that wheel beyond
45 the arm of the carrying-lever, so that the lever is free to yield to its spring *m* and to move toward the wheels and rotate the next higher wheel one number or point. The detent N is
50 detained momentarily from keeping company with the lever in this return movement until the pin P strikes the lever O and disengages the latter from the bar *g*, the detention being due to such engagement. The detent N then
55 resumes its normal position quickly under the power of its spring, locking the carried wheel against further movement. The operations of the carrying-lever M and the locking detent are relatively timed, it will be noticed, so that
60 the former has somewhat the start of the latter, thereby insuring the carrying rotation before the locking takes place. A feature of value in this stop-motion contrivance is that it is at liberty to move into locking position
65 before the rotation of the carried wheel has been completed, it only being necessary that it should allow the tooth previously held by it to pass. I thus insure its being in position

to engage the next tooth, while I prevent it from re-engaging the same tooth it has just released by detaining it momentarily, as specified. It will be understood that the operation
70 of the stop-motion will be precisely the same in the case of any other pair of adjacent wheels as that described in the case of the units and the tens wheels.
75

The setting of the machine preparatory to commencing an operation is by my present invention an easy and quick operation. A rotatable bar, R, having a flat side, is placed
80 transversely of the machine in the position indicated, and provided with a crank-arm, *r*, whereby it may be partially turned in its bearings. This arm *r* may be inside or outside
85 the case of the machine, as preferred, though I prefer to actuate it by a key, S', somewhat similar to the numeral-keys, and to locate it inside, as shown at Figs. 3 and 4. The flat side of the bar R acts upon the projection *s* upon the lower end of the detents N and forces said detents to release the numeral-
90 wheels, so that the latter are all free to be turned in the forward direction, and I actuate them in that direction through the main shaft B. The latter for this purpose is extended through the side of the case and provided with
95 a thumb-wheel, *b*, whereby power may be applied. Adjacent to the cam side of each numeral-wheel I insert in said shaft a pin, T, which, when the shaft is rotated, comes in contact with the abrupt face of a depressible
100 stop, U, projecting from the side face of each of the cams. As these pins are all in the same plane and the stops are located at the same point in all the wheels, it necessarily results that all the wheels may be rotated to indicate
105 the same figure by rotating the main shaft, the pins coming in contact with the stops at some point in the course of the revolution, such point depending upon the position occupied by the wheel when the setting is commenced.
110 To avoid the engagement of the pins T and the stops U when the wheels alone are rotated, as in adding, the stops are made sloping upon one side and inserted in recesses which allow them to sink out of the way when the pins
115 pass over such sloping sides. The construction I prefer for these stops and their holding recesses is clearly shown at Fig. 9. The stops are L-shaped, and when placed in position are securely held without being pivoted or other-
120 wise attached to the cam or wheel. At one extremity the stop is provided with a nib, *u*, which passes under the cam L, and another nib, *u'*, which enters the recess *u''* in the web of the wheel. This end of the stop is effectually held by these nibs, while they do not prevent the necessary motion at the other end.
125 At said other end is an enlargement, *u'''*, which engages with the cam L and prevents the throwing out of the stop under the pressure of the spring *u'''*, by which it is returned to its normal position after it has been depressed by the pin T. A recess, *u''''*, allows the enlarged end
130 *u'''* to pass inward when the stop is depressed.

The steps involved in the setting operation are, first, the drawing back of the detents N by the crank *r* and the bar R, and then the rotation of the main shaft B until all the wheels have been brought into line at the zero position. The pressure upon the crank *r* should be continued until the wheels have been rotated to indicate 7, or thereabout, when it may be released, and the detents N will then automatically catch and stop the wheels at the zero position.

It will be noticed that I have provided in my machine for the adding of fractions $\frac{1}{2}$, $\frac{1}{3}$, $\frac{1}{4}$, &c. The only changes necessary to adapt my machine to this work are the provision in the ratchet F of eight teeth instead of ten, a like number of teeth *i*, seven keys instead of nine, a proper graduating of the keys, and the changes in the numerals upon the wheel; but in principle the machine for adding fractions is unchanged from that used for whole numbers, and it will be understood that other fractions than the particular ones illustrated may be added in my machine if similar changes to those mentioned be made.

A feature of great importance in my machine is the provision for excess motion by the disks E². I have shown at Fig. 8 the relative position of the pawl carried by said disk and the ratchet F when at rest, and it will be noticed that the pawl must move some distance before it engages with the ratchet and moves the latter. This preliminary or excess movement upon the part of the disk and pawl, while not necessary so far as actuating the ratchet is concerned, is essential to enable the disk to release the ratchet and number-wheel from the lock of the detent N before movement is imparted to them, as will be readily understood.

At Figs. 12 and 13 a modification of the carrying stop-motion is illustrated. The spring-actuated detent N', corresponding to the detent N, already described, is provided with a similar pin, *n'*, intended to engage with the notched periphery of disk E², and is detained for the same purpose as detent N is detained by a spring-catch, V', and released from said catch by providing the lever M with a flange, *m*⁵, which will act as a cam to force said catch away from the detent. The detent is drawn back by the carrying-lever M through the medium of a pin, P', upon the latter.

In Fig. 14 the detent N² corresponds with detent N in that it locks the numeral-wheel in a similar way, is provided with a similar pin, *n*², engaging with the notched disk E², and is drawn back by a pin, P², upon the carrying-lever passing through an elongated opening, *p*, in the detent. With this detent I have shown no detaining device, and I regard it, therefore, as a less desirable construction than the forms wherein the detent is held back to give the carrying-lever time to do a part at least of its work.

Figs. 15 to 18 illustrate a modification of

the construction of the connection between the stop-levers G and the vibrating detents J'. The rods J are here employed, but they are attached to the detents by looping their upper ends and passing such loop over guide-heads Z, the loops allowing the rods to move some distance with the stop levers before they actuate the detents, thus accomplishing the result dwelt upon above of getting the stop-levers under motion before they begin to actuate the detents. The attachment of the rods to the levers is also different from that previously shown and is a rigid one. It consists in bending the ends of the rods at right angles and passing the extremities thereof through openings in the vertical webs of the levers. Retaining loops or staples *z* are then passed around the rod and soldered to the upper surface of the levers. By making the heads Z oblong, as shown, the loops of the rods may be slipped over them while held horizontally, and by then swinging them to the vertical position they become fastened or movably held. This same result would follow, of course, if the heads could be partially rotated upon their axes; but I prefer to rivet them to the detents, so they cannot be detached or moved.

The springs *n* and *o* may both be formed in one piece and are so indicated in the drawings.

I claim—

1. In an adding-machine, the combination, with the several numeral-wheels and their carrying mechanisms, of actuating-key mechanism for each of said wheels and positively-acting stop-motion detents for preventing over-rotation under the impulses of said keys or carrying mechanism, substantially as specified.

2. In an adding-machine, the combination, with the numeral-wheels, their key-actuating devices, and their carrying mechanisms, of detents for preventing overrotation under actuations received directly from the keys, and other detents for preventing overrotation under actuations by the carrying mechanisms, substantially as specified.

3. In an adding-machine, the combination, with the series of numeral-wheels and their actuating devices, of the series of levers for actuating said wheels in carrying, the series of springs in which power is stored for actuating said levers, and the series of positively-acting stop-motion detents for preventing overrotation under the impulse of the carrying-levers, substantially as specified.

4. In an adding-machine, the combination, with each numeral-wheel and its carrying-lever, of a positively-acting stop-motion detent acting upon the wheel, and a spring for throwing said detent into engagement, substantially as set forth.

5. In an adding-machine, the combination, with each numeral-wheel and its carrying-lever, of a positive stop-motion detent, a spring for throwing the detent into engagement, and a catch or equivalent detaining device for de-

taining the detent momentarily, substantially as set forth.

6. In an adding-machine, the combination, with the numeral-wheels, of the spring-actuated positive detent N and the notched disk E², having a movement independent of its wheel for releasing the wheel from the lock of said detent before said wheel is actuated, substantially as specified.
7. In an adding-machine, the combination, with the numeral-wheels, of the spring-actuated positive detent N, the carrying-lever, and the notched disk having a movement independent of its wheel for releasing the wheel from the lock of the detent before said wheel is actuated, substantially as set forth.
8. In an adding-machine, the combination, with the carrying-lever and its actuating cam, of the spring-actuated detent N, the pin upon the carrying-lever for drawing the detent back, the bell-crank lever, and the bar under which the latter catches, substantially as set forth.
9. In an adding-machine, the combination of the stop-levers with the numeral-wheels, their actuating devices, the locking-detents J', and the connecting-rods J, the stop-levers having an excess of motion whereby they are enabled to get under way before actuating the detents, substantially as specified.
10. In an adding-machine, the combination of the numeral-wheels, their actuating devices, the detents J', the connecting-rods J, and the stop-levers, the latter having an excess motion, as specified, and both detents and levers having separate lifting-springs, substantially as specified.
11. The combination of the numeral-wheels, their actuating devices, detents J', and the rod J with the stop-levers inclosed in elongated loops at the lower ends of the rods, substantially as specified.
12. The combination of the numeral-wheel, its actuating-segment, the series of keys, and the stop-motion detent J', the lowest key being connected to the detent, so as to actuate the same directly, and the other keys acting thereon through the stop-lever and rod J, with the stop-lever and rod, substantially as specified.
13. In an adding-machine, the combination of the numeral-wheels, their actuating-segments, and the stop-motion detents J', with the lowest key of each series of keys, the latter being connected directly to and actuating said detents, substantially as specified.
14. The stop-levers having the forked ends, in combination with the several series of keys actuating said levers, the lowest key of each series acting as a guide to one of the levers, substantially as specified.
15. The combination of the stop-levers with the several series of keys actuating the same,

the lowest key of each series being let into the end of the levers, and the cross-bar G², substantially as set forth.

16. The combination of the numeral-wheels in series, all borne upon a single shaft and provided with depressible stop-latches U, as specified, with said shaft, and the pins T, driven into said shaft for engaging said stops and rotating said wheel, substantially as set forth.

17. The rotatable main shaft and the numeral-wheels mounted thereon, said shaft having latches for engaging said wheels during its rotation, in combination with the positive locking-detents and the rotatable bar R, for releasing the detents to permit said wheels to be returned to O by revolving said shaft, substantially as set forth.

18. The numeral-wheels provided with spring-latches U, the shaft upon which the numeral-wheels are loosely mounted, said shaft being provided with pins T to engage said latches and rotate the wheels in one direction, the locking-detents, and the bar R, for releasing the wheels from said detents, in combination with the stops upon the wheels to engage with said pins and said detent, substantially as set forth.

19. The pinions E' and the disks E², notched upon the periphery, in combination with the numeral-wheels A, the ratchets F, the pawl e, normally resting on said ratchet near the point a tooth, and detents N, substantially as set forth.

20. The numeral-wheels, the actuating-ratchets, and the disks E², carrying the pawls acting upon said ratchets and also acting to release the positively-acting locking-detents N, in combination with said detents, the disks having some excess motion before moving the ratchets to give time for releasing the lock of the detents, substantially as set forth.

21. In an adding-machine, the combination, with the numeral-wheels, of the carrying mechanisms and the positively-acting stop-motion devices for preventing overrotation under the carrying impulses, the hook o', and bar g, whereby said stop-motion devices are caused to act an instant later than the carrying devices, substantially as set forth.

22. The combination, with the carrying-lever, of a positively-acting stop-motion detent for preventing overrotation under the impulse of the carrying, said detent being automatically withdrawn from engagement with the numeral-wheel by the lever as the latter moves back preparatory to a carrying operation, substantially as set forth.

DORR E. FELT.

Witnesses:

H. M. MUNDAY,
LEW. C. CURTIS.